

DH
series

Power relay series pursuing reliability and safety

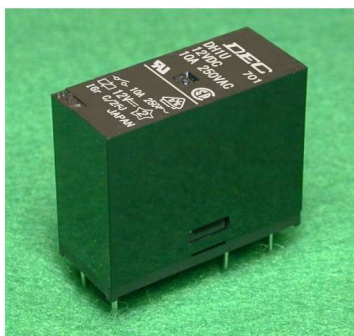

DH1U-10A
(1 pole, standard type)

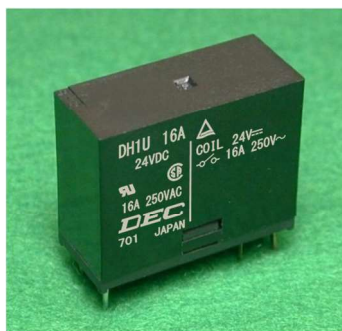

DH1U-16A
(High-capacity, 1 pole, 16A type)



DH1U-II
(1 pole, seal type)



DH1FU
(1 pole, tab terminal type)



DH2U
(2 poles, standard type)



DH2TU
(2 poles, crossbar twin contacts)

■ Currently it is used for such purposes

- Control panel, Power supply equipment, Molding equipment, Machine tools, Welding machines, Machinery for agriculture
- Commercial equipment, Vending machines, Telecommunications equipment, Disaster prevention equipment, Copiers, Measuring instruments, Medical devices
- Various household appliances
- DH2TU is ideal for audio system protection

DEC is a professional manufacturer of relays

DH series

■ Features

- It is a general purpose power relay of 1-pole 10A, 16A, 2-poles 5A boasting high reliability and achievement.
- PCB type and tab terminal type are prepared.
- Small size, easy to use 1-pole and 2-poles relay.
- DH2TU is ideal for audio speaker protection etc.

■ Model numbering system



Rated coil voltage:	Numeric part indication DC (V): 5, 12, 24
Coil type	D: DC
Number of contact poles	1: 1 pole 2: 2 poles
Shape indication	O: PCB terminals F: Flange-mounting type (#187 tab terminal)
Contact configuration	(M): Make contacts T(M): Crossbar twin contacts (GS alloy) Nil: Transfer contacts
Notes	II: Seal type 16A: High-capacity, 1-pole, 16A type

■ Safety standards

	Contact rating (1-pole)			Contact rating (2-poles)		
	DH1U	DH1U-II	DH1U-16A	DH1FU	DH2U	DH2TU
UL	10A 250V AC 8A 265V AC 1/3hp 265V AC TV-8/120VAC	16A 250V AC 8A 265V AC 1/3hp 265V AC	16A 250V AC	10A 277V AC	5A 265V AC 3A 30V DC 1/12hp 265V AC TV-3/120VAC	3A 120V AC 3A 30V DC
CSA	10A 250V AC 10A 30V DC TV-8/120VAC	16A 250V AC	16A 250V AC		5A 250V AC 3A 30V DC 1/4hp 240V AC TV-3/120VAC	3A 120V AC 3A 30V DC
VDE	10A (cos φ=1) 7.5A (cos φ=0.4) 250V AC	16A (cos φ=1) 12A (cos φ=0.4) 250V AC		10A (cos φ=1) 250V AC		
SEMKO					5A/60A 250V AC	
TUV	5A (cos φ=1) 250V AC 3A (cos φ=0.4) 250V AC 5A (L/R=0ms) 30V DC 5A (L/R=7ms) 30V DC		16A 250V AC			
CQC		16A 250V AC				

Electrical Appliances and Materials Safety Act

Conformable

■ Coil ratings

AC/DC	Item Voltage	Rated current (mA)	Coil resistance (Ω)	Operate voltage (V)	Release voltage (V)	Maximum voltage (V)	Power consumption (W)
				Ratio to rated voltage			
DC	5	106	47	80% max.	10% min.	110%	0.53
	12	44	275				
	24	22	1100				

- Notes: 1. Rated current and coil resistance are values at coil temperature of 20°C, tolerance is ±10%.
- 2. Operate voltage and release voltage are values at coil temperature of 20°C.
- 3. Maximum voltage is the maximum value of the allowable voltage fluctuation range of the relay coil operating power supply with the ambient temperature at 20°C.

DEC is a professional manufacturer of relays

DEC Daiichi Electric Co., Ltd.
<https://www.j-dec.co.jp>

DH series

Ratings • Performance

Specifications	Item	Performance (1-pole type)			
		DH1U	DH1U-16A	DH1U-II	DH1FU
	Features	1 pole, standard type	Two terminals on PCB side	Seal type	Tab terminal
Contact specification	Contact configuration	1a/1c	1a	1a	1a/1c
	Contact resistance	50mΩ max. (at DC6V 1A)			
	Contact material	Ag alloy			
Ratings	Rated load (resistive load)	AC250V 10A	AC250V 16A	AC250V 16A	AC250V 10A
	Max. switching capacity (resistive load)	2500VA	4000VA	4000VA	2500VA
	Max. switching voltage	AC250V			
	Max. switching current	10A, TV-8	16A	16A	10A
Electrical capability	Insulation resistance	100MΩ min. (at DC500V)			
	Dielectric strength	Between coil and contact	AC4000V 1 min		
		Between open contact	AC1000V 1 min		
	Impulse withstand voltage (between coil and contact)	10 000V min. (1.2 × 50 μs)			
	Operate time (at rated voltage on, at 20°C)	15ms max. (excluding contact bounce time)			
Mechanical capability	Release time (at rated voltage off, at 20°C)	1a: 5ms max. (excluding contact bounce time)			
		1c: 15ms max. (excluding contact bounce time)			
	Vibration resistance	Malfunction	1a: 10 to 55 to 10Hz (double amplitude 1.5mm)		
Life	Electrical endurance (resistive load) (at 20 times/min)	100 000 times min. (at rated load)			
		1000 000 times min.			
Conditions for operation	Ambient temperature	-15°C to +60°C (no freezing and condensing at low temperature)			
	Ambient humidity	5% to 85%RH			
Mass		approx. 17g	approx. 19g	approx. 17g	approx. 20g

Specifications	Item	Performance (2-poles type)		
		DH2U	DH2TU	
	Features	2 poles, standard type	High contact reliability	
Contact specification	Contact configuration	2a/2c	2a (cross bar twin contact)	
	Contact resistance	50mΩ max. (at DC6V 1A)	30mΩ max.	
	Contact material	Ag alloy	Ag-GS clad	
Ratings	Rated load (resistive load)	AC250V/DC30V 5A	AC120V/DC30V 3A	
	Max. switching capacity (resistive load)	1250VA	360VA	
	Max. switching voltage	AC250V	AC120V	
	Max. switching current	5A	3A	
Electrical capability	Insulation resistance	100MΩ min. (at DC500V)		
	Dielectric strength	Between coil and contacts	AC4000V 1 min	
		Between open contacts	AC1000V 1 min	
		Between opposite polarity contacts	AC1000V 1 min	
	Impulse withstand voltage (between coil and contacts)	10 000V min. (1.2 × 50 μs)		
Operate time (at rated voltage on, at 20°C)	20ms max. (excluding contact bounce time)			
Mechanical capability	Release time (at rated voltage off, at 20°C)	2a: 10ms max. (excluding contact bounce time)		
		2c: 20ms max. (excluding contact bounce time)		
	Vibration resistance	Malfunction	2a: 10 to 55 to 10Hz (double amplitude 1.5mm)	
Life	Electrical endurance (resistive load) (at 20 times/min)	100 000 times min. (at rated load)	10 000 times min. (at rated load)	
		1000 000 times min.		
Conditions for operation	Ambient temperature	-15°C to +60°C (no freezing and condensing at low temperature)		
	Ambient humidity	5% to 85%RH		
Mass		approx. 18g		

● Notes: The above is the initial value.

DEC is a professional manufacturer of relays

DEC Daiichi Electric Co., Ltd.

<https://www.j-dec.co.jp>

DH series

■ Dimensions

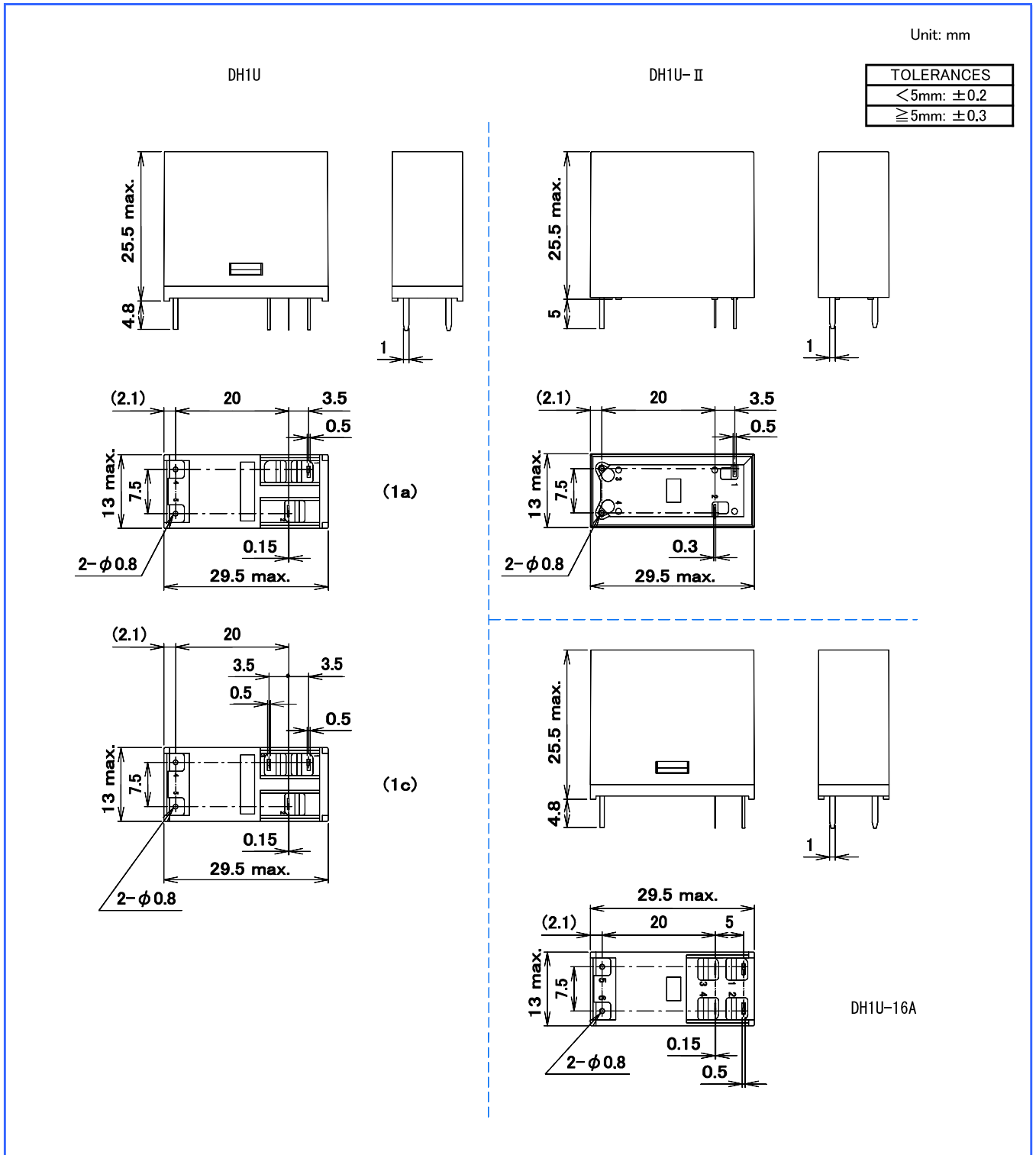

DEC is a professional manufacturer of relays

DEC Daiichi Electric Co., Ltd.
<https://www.j-dec.co.jp>

DH series

■ Dimensions

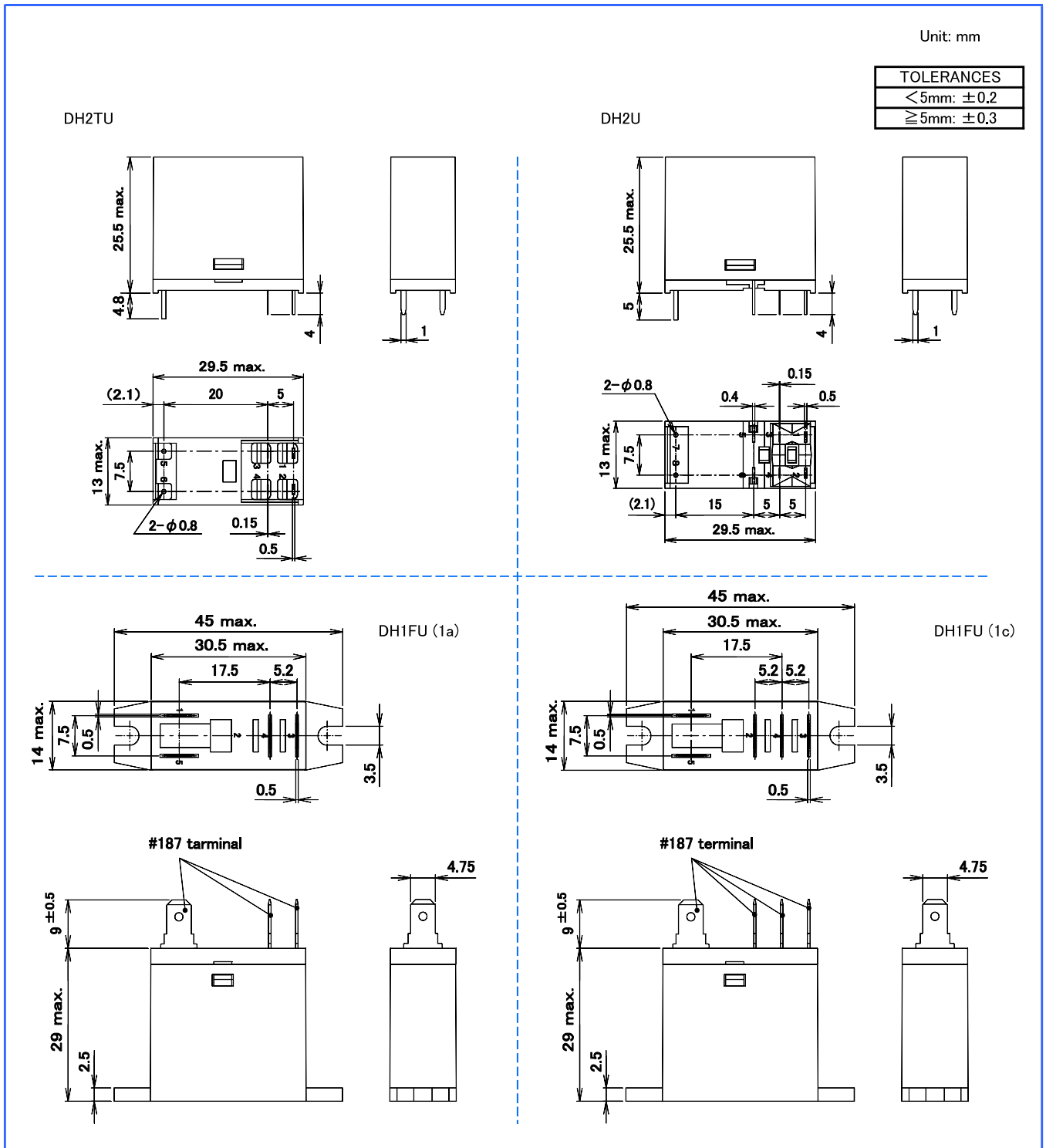

DEC is a professional manufacturer of relays

DH series

Schematics

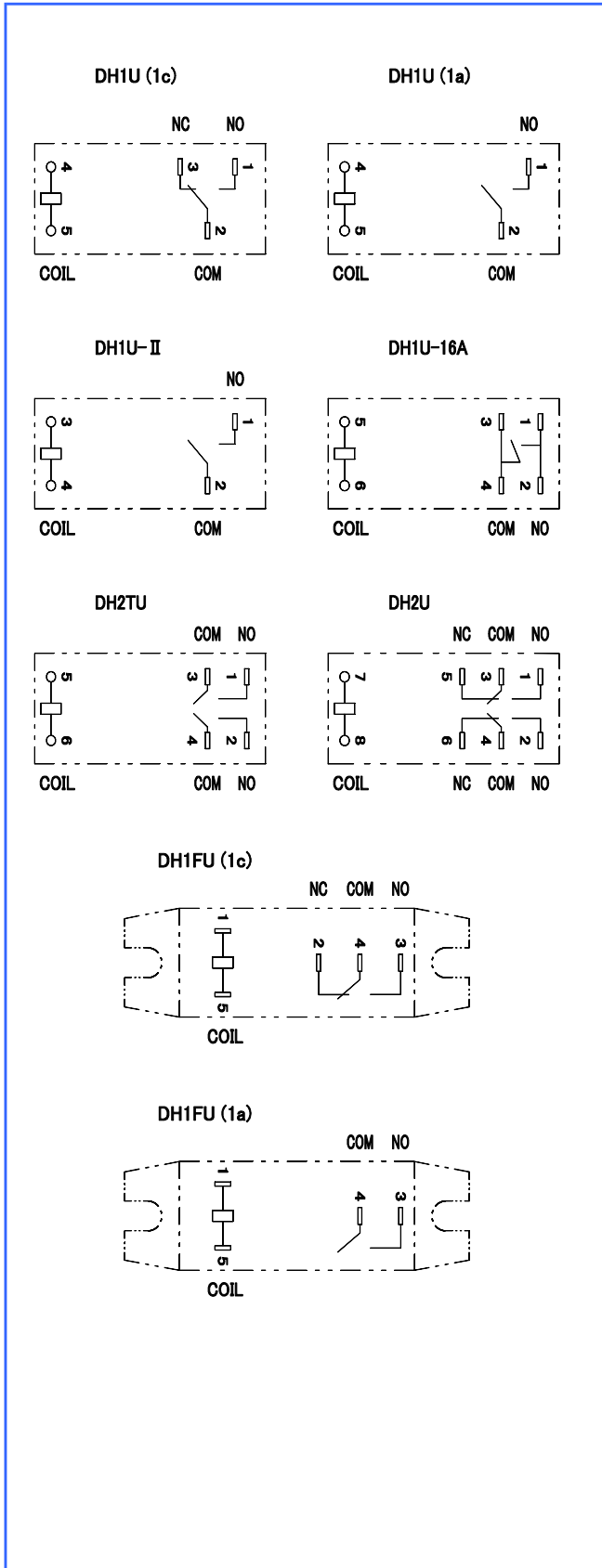

PCB mounting holes (tolerances ±0.1)

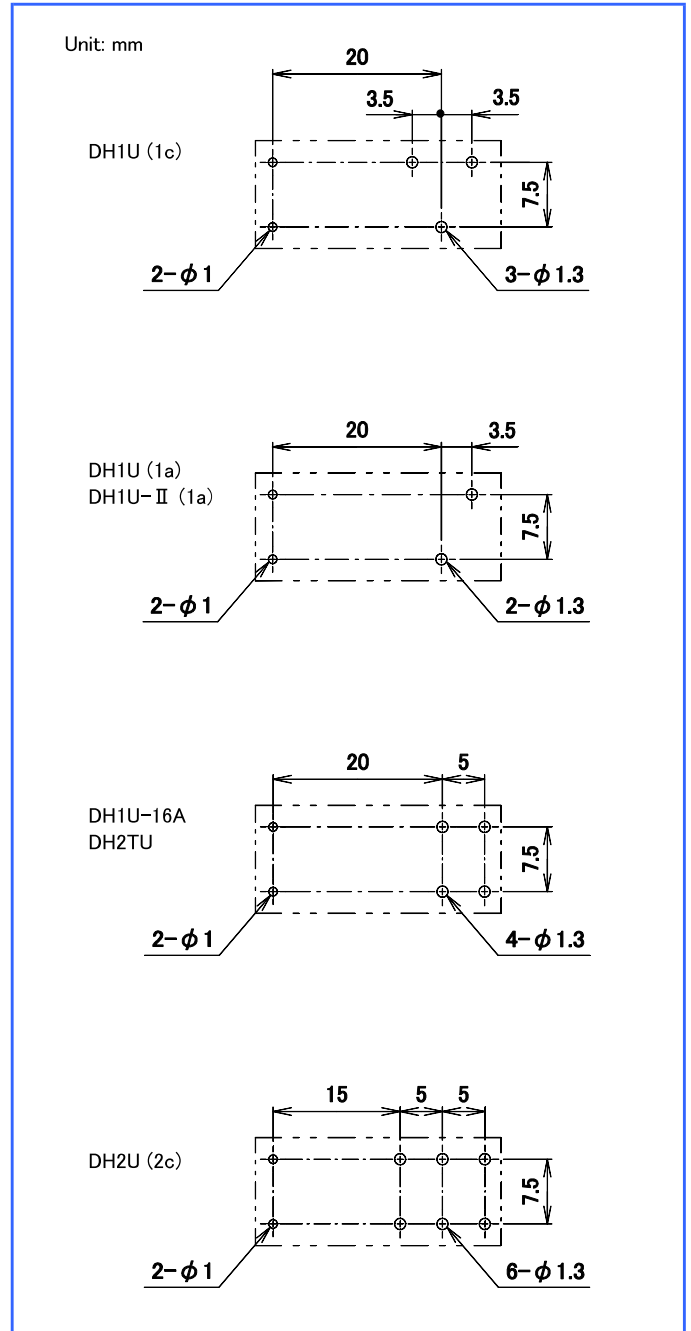

Mounting holes (tolerances ±0.1)

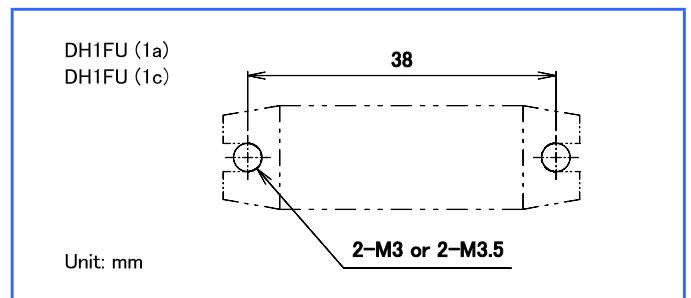

DEC is a professional manufacturer of relays

DH series

Reference data

■ Maximum switching capacity

DH1U-16A

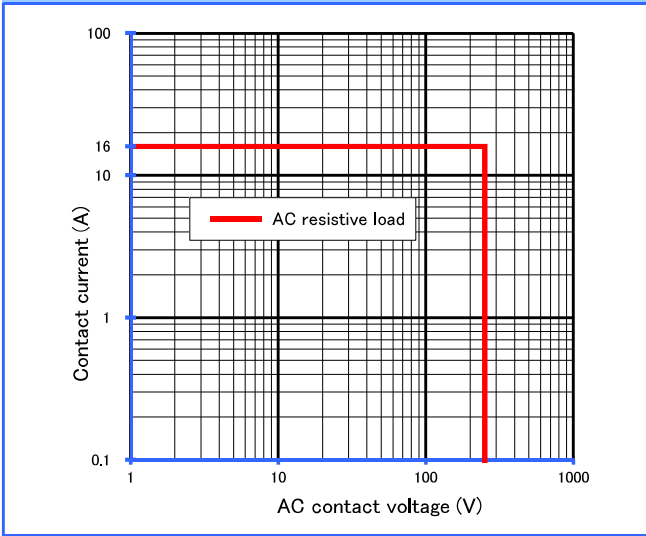

■ Durability curve

DH1U-16A

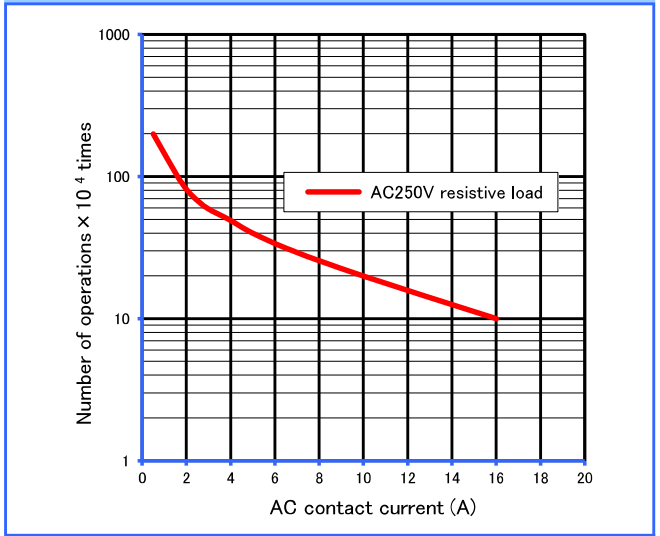

DH1FU

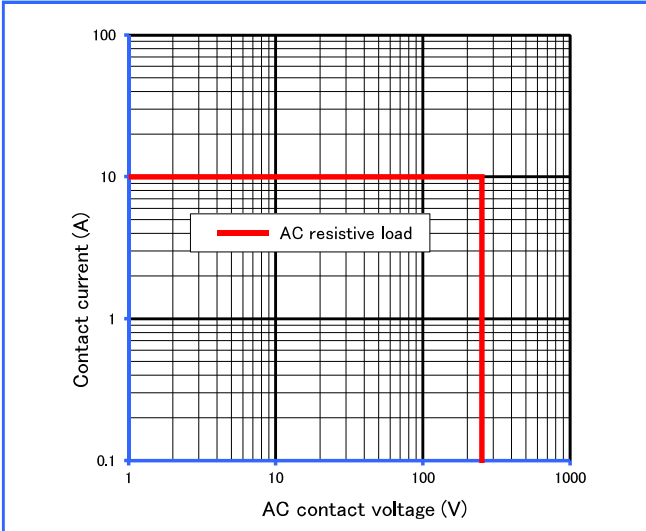

DH1FU

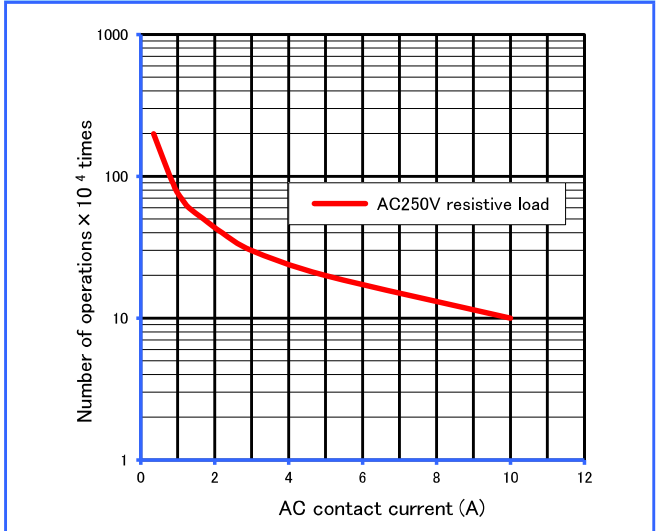

DH2TU

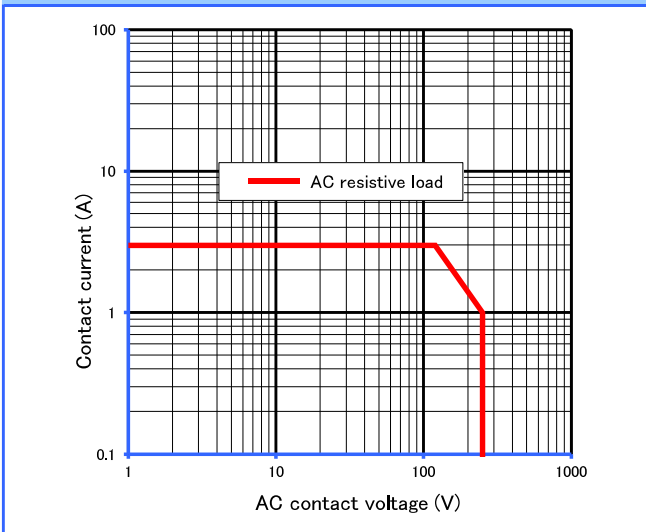

DH2TU

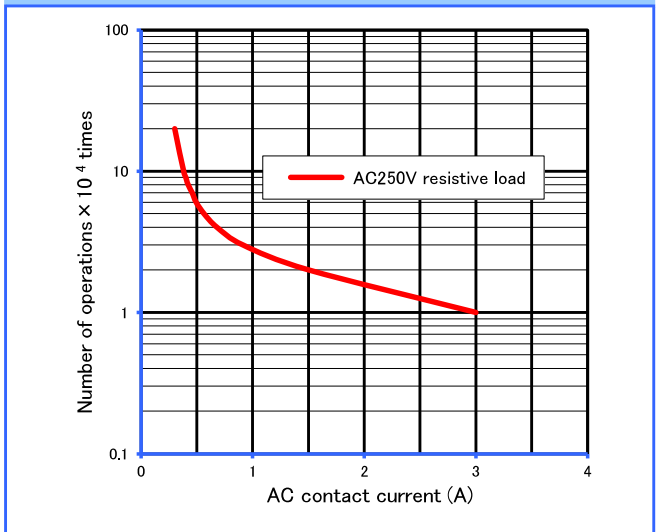

DEC is a professional manufacturer of relays

DH series

Reference data

Maximum switching capacity

DH1U

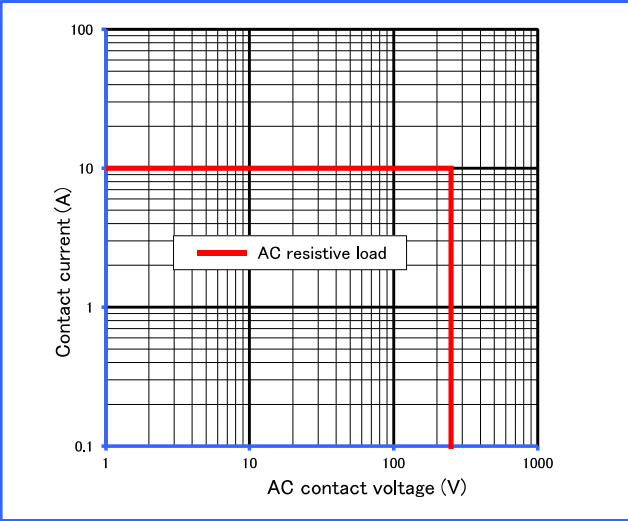

Durability curve

DH1U

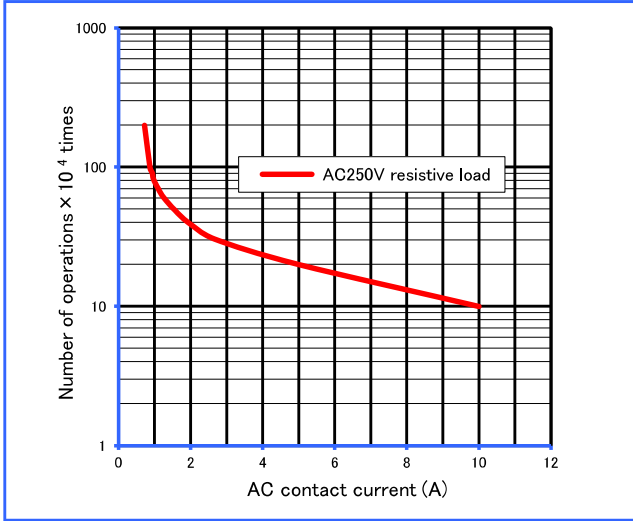

DH1U-II

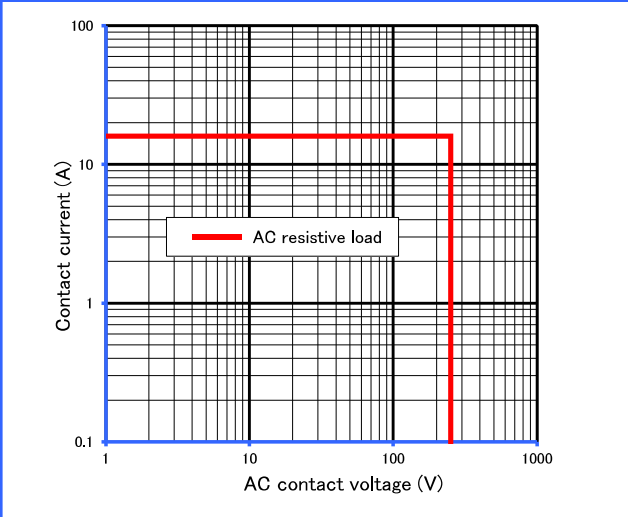

DH1U-II

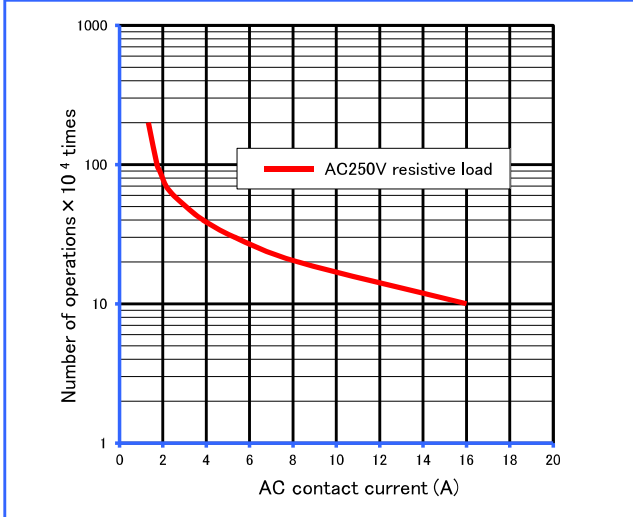

DH2U

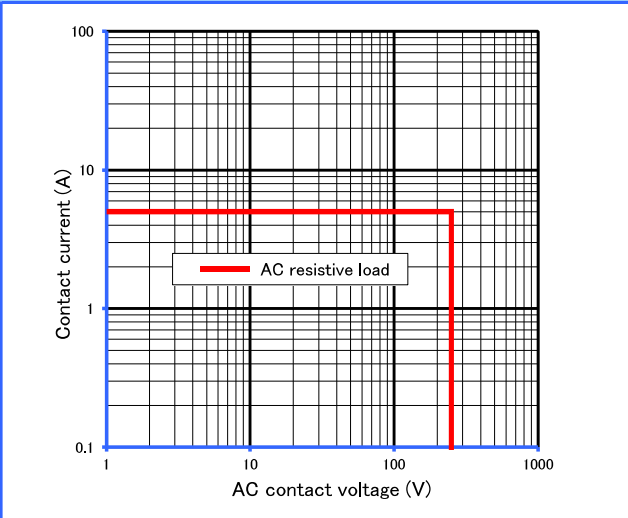

DH2U

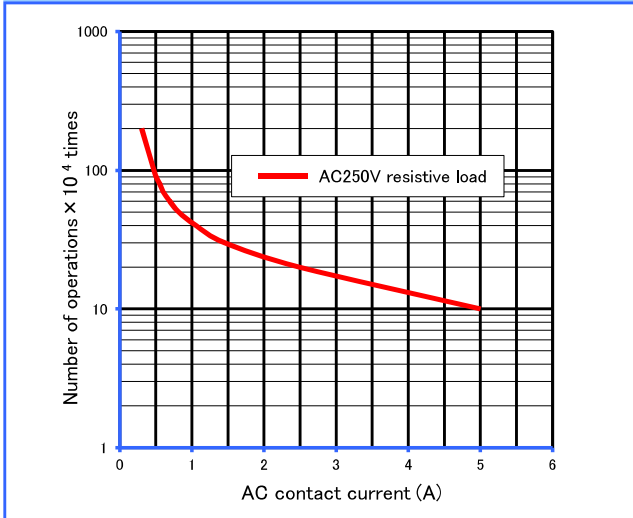

● Please understand that specifications may be changed without notice due to product improvement etc. ● Dimensions and specifications indicate only major points. Please contact our sales representatives for details.

DEC is a professional manufacturer of relays

DEC Daiichi Electric Co., Ltd.

Head office 2-2, Noge 3-chome, Setagaya-ku, Tokyo 158-0092, Japan

Phone +81-3-3703-5421

Facsimile +81-3-3703-5426

U R L <https://www.j-dec.co.jp> E-Mail: sales@j-dec.co.jp

Agency